



PRODUCT

SANDOR

Product code SANDOR PLUS SMA

SANDOR PLUS SMA



DOUBLE OPTIC PERIMETER BARRIER

INSTALLATION AND MOUNTING MANUAL VERSION 2.6

Table of contents

1. Introduction.....	3
2. Product description.....	3
3. General warnings.....	4
3.1 Additional warnings for devices powered by mains voltage	
3.2 Installation warnings	
4. List of main components	5
5. Preparation for installation	6
5.1 Preparation of the barrier parts before installation	
5.2 It is advisable to carry out	
6. Assembly / fixing examples	7
6.1 Installation placement and height	
6.2 Placement and assembly	
7. Evaluations before installation.....	9
7.1 Introduction to barriers	
8. Barrier positioning.....	10
8.1 Precautions before installation	
9. Installation examples	11
9.1 Barrier control	
10. Wiring.....	12
10.1 Type of cable	
10.2 Connection of cables from power supply to barrier	
11. Connections to the terminal board.....	14
11.1 Wire synchronism	
11.2 Connection for synchronism	
12. Barrier alignment.....	17
12.1 Calibration using SMA system	
12.2 Alignment	
12.3 Parallel beam calibration	
12.4 Calibration with active crossing function	
13. Optical synchronism	21
14. Basic functions	22
14.1 Basic settings and programming - MES9012 board	
15. Intervention time adjustment.....	23
16. Appendix A: motherboard setting and programming (MES9012)	24
16.1 Motherboard components	
16.2 LED signal operation	
16.3 Characteristics of settings	
17. Appendix B: optical board configuration	28
17.1 Transmitter optics	
17.2 Receiver optics	
18. Appendix C: configuration with 3/2 receivers	30
18.1 Setting 3 RX models	
18.2 Setting 2 RX models	
19. Appendix D: serial connection to the Adbus concentrator	31
19.1 Serial port connection for each barrier	
20. Appendix E: single barrier with optical synchronism	32
21. Technical characteristics	33
22. F.A.Q.....	34
23. Product disposal	36

1. Introduction

Congratulations on having purchased the Politec perimeter barrier. This appliance guarantees long-lasting and reliable operation if installed correctly. For correct and effective use, it is necessary to read this instruction manual carefully.



The system has been designed to detect intrusions and activate the alarm; it is not a device that prevents intrusion. Politec is not responsible for damage, injury or loss caused by accidents, theft, force majeure (including momentary lightning-induced overcurrent), abuse, improper or incorrect use, faulty installation or inadequate maintenance.

2. Product description

The double optic infrared perimeter barrier consists of an infrared receiver and transmitter. Operation is based on the "AND" logical operations: in other words, the alarm is activated only in the event of simultaneous interruption of two superimposed beams.

This barrier is ideal for perimeter protection of internal and external areas.

It is equipped with a system for selecting the operating frequency that allows you to install multiple barriers on the same site without them interfering with each other. The main features of this barrier are:

- Adjustable intervention time which allows you to adapt to the characteristics of the site to be protected;
- Protection beam angle adjustment both vertically and horizontally;
- Set up for mounting on a wall, on a pole and on aluminium columns;
- Optical alignment with viewfinder and signal measurement points;
- Contact signalling barrier opening.



Instructions/Warnings

Mounting, installation of the barrier and connection to the mains must be carried out by expert and qualified personnel, in compliance with rules and regulations applicable to electrical systems.

3. General warnings

This installation manual contains important information regarding safety for installation: it is necessary to read all the instructions before proceeding with the installation.

Keep this manual for future use.

- If you have any questions or doubts during installation, do not carry out any operations and contact the support service.
- Use of these products for purposes other than those specified in these instructions is prohibited.
- You must not make any change to the components of the product unless stated in the manual in order not to void the warranty; such operations can only lead to malfunctions; Politec assumes no liability for malfunctions or damage due to modified products.
- Depending on the specific situation of use, check for the need for additional devices: detectors or signalling devices.
- During installation, mounting and use of the product, make sure no foreign objects (solids, metals or liquids) are able to penetrate inside the open devices.
- Manufacturer's liability: Politec assumes no liability for failures resulting from incorrect installation; lack of maintenance, incorrect assembly or use.
- Politec is also not liable for incorrect or incomplete operation of the product or failure to detect intrusion.
- Warranty (summary of conditions): Politec guarantees its products for a period of 2 years from the production date. The warranty is applied to those purchasing directly from Politec; there is no warranty for the end user who, in the event of breakdowns or faults, must contact the installer or dealer.
- The warranty excludes aesthetic parts as well as parts subject to normal wear and parts subject to normal consumption such as batteries and accumulators.

3.1 Additional warnings for devices powered by mains voltage

This manual is intended only for technical personnel qualified to install such devices.

- Assessing the hazards that may occur during installation and use of the system, in order to achieve complete safety, it is necessary that installation takes place in full compliance with applicable laws, methods, rules and regulations.
- Before accessing the internal terminals of the product, it is necessary to disconnect all the power circuits.
- If automatic circuit breakers or fuses trip, before resetting them it is necessary to identify the fault and repair it.

3.2 Installation warnings

- Check that all the material to be used is in excellent condition and suitable for use.
- Before proceeding with the installation, check the environmental class of the products in the "technical specifications" chapter.
- Check, by comparing with the values shown in the paragraph "technical specifications", that the range of the devices is equal to or greater than the physical distance between the barriers.
- Check that the barrier is positioned in areas protected against potential impact, in flat areas and on fixed supports to avoid oscillations.
- Do not place the system components close to heat sources as they could be damaged.
- Each barrier has its own operating principle: check the instructions for choosing the right position in the respective instruction manual.



4.List of main components

The package contains the following components and accessories.

When opening the package, check that everything has been included.

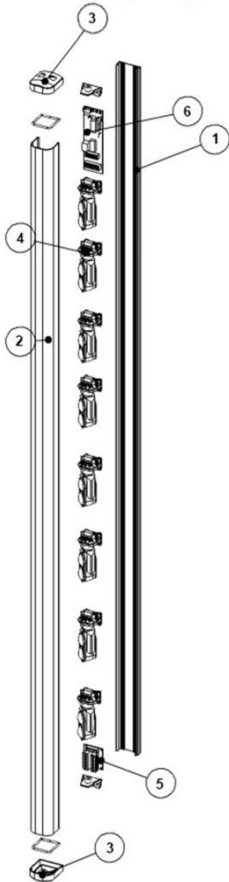

No	COMPONENT
1	Aluminium profile
2	Polycarbonate black cover
3	Caps
4	Transmitter \ Receiver optics
5	MES9C Terminal board
6	MES9012 Motherboard

5. Preparation for installation

5.1 Preparation of the barrier parts before installation

Since the communication between the barriers can take place wired, via wireless and their alignment can be done optically, it is advisable to firstly check all the component parts of the barriers and any accessories before beginning the installation.

5.2 It is advisable to carry out:

- device configuration on a table;
- a check on the operation of the optical and acoustic alignment
- the permanent fixing of each device;
- the preparation and carrying out of electrical connections.

In order to avoid errors, operating and installation problems, it is advisable to proceed as follows:

- a) Place all the products with the package open on a table;
- b) For the low consumption barrier version for wireless models with universal electronic board housing, insert and connect the radio transmitter, and connect it to the barrier receiver board
- c) Power up the barriers and program them
- d) Test barrier operation;
- e) Place (without fixing) the barriers at the planned points;
- f) Place (without fixing) all the other devices at the planned points;
- g) Check for each barrier that there is sufficient field for radio communication (for wireless versions);
- h) Permanently fix the barriers.

Before proceeding with the installation, it is necessary to check the integrity of the product, the adequacy of the model chosen and the suitability of the environment intended for installation:

- Check that all conditions of use fall within the "limits of use" and in the "Technical specifications of the product".
- Check that the environment chosen for the installation is compatible with the total footprint of the product.
- Check that the surface chosen for the installation of the product is solid so as to ensure stable fixing and that it is adequately protected from possible impacts or atmospheric agents.



6.Assembly/fixing examples

6.1 Installation placement and height

Position the barrier considering the type of surrounding environment and the protection distance for correct and effective operation.

Position it in such a way that there are no obstacles in its range of action (trees/plants or objects that can swing or move with the wind or rain).

Position the barrier so that the sunlight does not hit it directly near the RX sensors.

However, it is necessary to take into consideration the specific beam diffusion of each model, to avoid reflection of the rays caused by the ground or by adjacent objects.

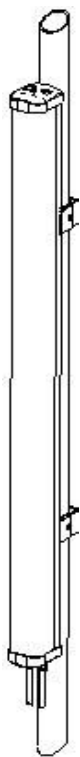

**Pole mounting
with SAN/PL brackets**

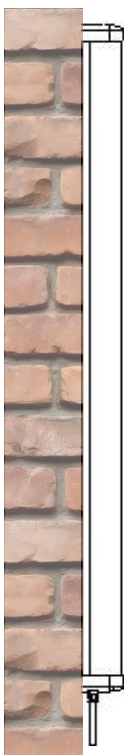

**Wall mounting with
SAN/SD brackets**



**Wall mounting with
SAN/PL pole brackets
(recommended for
protection of sections
along the wall)**

6.2 Placement and assembly

It is highly recommended to always request and use the accessory brackets for fixing the columns, avoiding to drill the aluminium structure.

Pole mounting with SAN/PL

SAN/PL brackets allow fixing on poles type SAN/TB1 and SAN/TB2 with a diameter of 48 - 50mm in a very simple way as seen in the figure.

- Each column requires a minimum of 2 brackets or more if the column is very high.
- The poles are equipped with a base for fixing to the floor or to the POB30 cable pit to be cemented into the ground, also with the function of branch junction box.
- The connection cables enter from the lower cover of the column, equipped with O rings and cable glands.

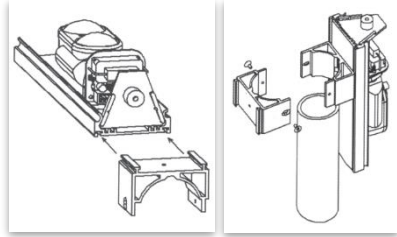

Wall mounting with SAN/PL

The SAN/PL brackets also allow fixing to the wall, in a very simple way as seen in the figure.

- It is recommended to use these, when protecting windows, doors, etc., along the wall, in order to avoid small obstacles, such as hinges, edges of the windowsills, which could be in the beams creating an attenuation of the signal.
- Each column requires a minimum of 2 brackets or more if the column is very high.

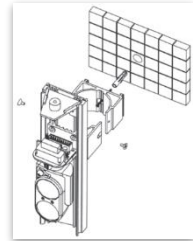

Wall mounting with SAN/SD

The SAN/SD brackets supplied in a kit of 2 pieces allow wall mounting and are invisible, as seen in the figure.

- These brackets are recommended when the columns are placed in front of each other or the internal optics are rotated to less than 90° horizontally.
- Each column requires a kit consisting of two brackets, which are fixed to the ends of the column, leaving only the holes for wall fixing visible.
- Once all the installation and functional operations have been completed, the two covers will hide the part with the fixing holes.

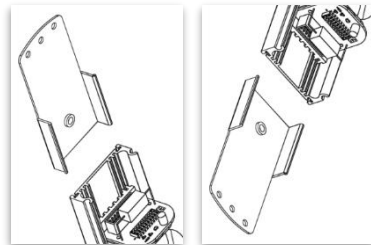

WARNING:

Product warranty is invalid if there is any hole in the aluminium profile or any component

7. Evaluations before installation

7.1 Introduction to barriers

The Active Infrared Barrier is characterised by two components, a TX transmitter that impulsively emits an infrared signal, towards the RX receiver. This signal is constantly controlled by a **CODED SYNCHRONISM** which can be **WIRED or OPTICAL** according to the different types of barriers.

The transmitted infrared beam takes on a conical shape: the greater the distance between TX and RX, the greater the diameter of the cone when it arrives.

View from above

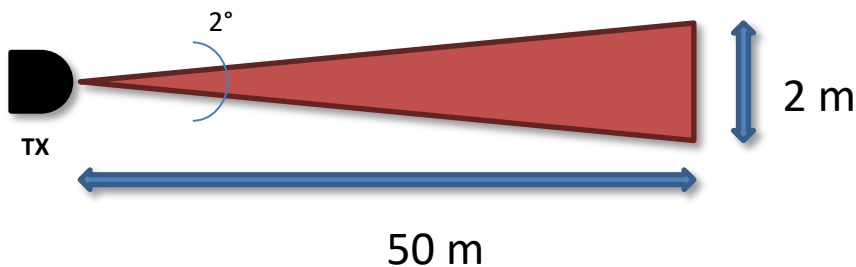

Signal interruption:ALARM

A barrier can be composed of several TX transmitters and RX receivers mounted inside specific different columns.

The infrared barriers have multiple controls that significantly limit false alarms, as the genuine alarm signal is given by the complete interruption of the infrared signal.

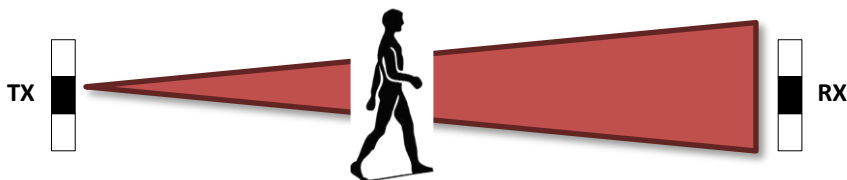

HEATERS

It is recommended to power the thermostating system as, in conditions of high humidity, the condensation that is created on the screen can lead to a significant decrease in the IR signal up to the alarm. For obvious reasons, for battery powered barriers, there is no thermostat control even if set up, therefore to minimise the problem, it is necessary to reduce the working distance between TX and RX, thus ensuring a good amount of signal constantly, even in case of particular climatic conditions.

8. Barrier positioning

8.1 Precautions before installation

Before placing the barriers outdoors, you must bear in mind that the infrared beam has a conical shape: the greater the distance between the column, the greater the diameter of the cone when it arrives. In order not to generate false alarms, you must place the barriers away from reflecting surfaces, away from walls or anything that can attenuate the signal.

DO NOT place the barriers if there are plants, bushes or fixed objects in the range that obstruct the signal and create "grey areas". Leave a corridor of 50cm for distances between columns greater than 50m

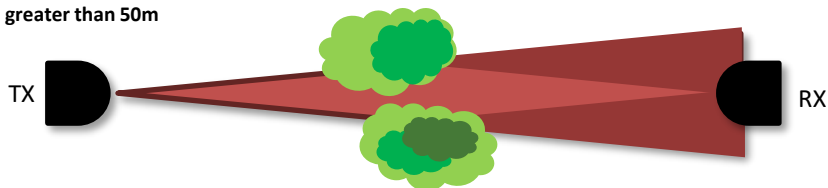

DO NOT place the barriers close to walls, without spacing the columns with adequate brackets: the signal quality may decrease

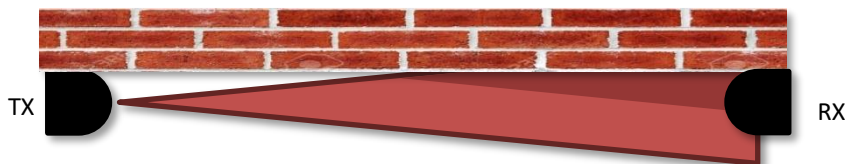

DO NOT place barriers close to roads: vehicle lights directed towards the RX could create disturbances

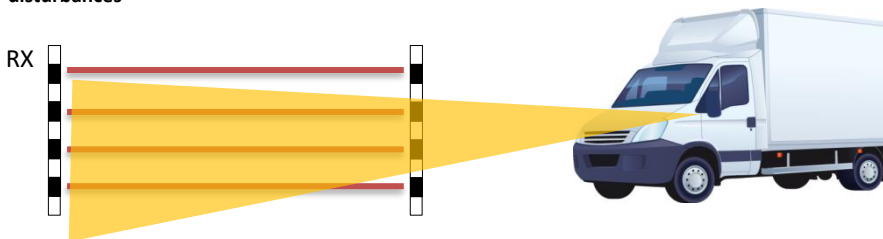

DO NOT place barriers near automatic gates: photocell signals can create interference.

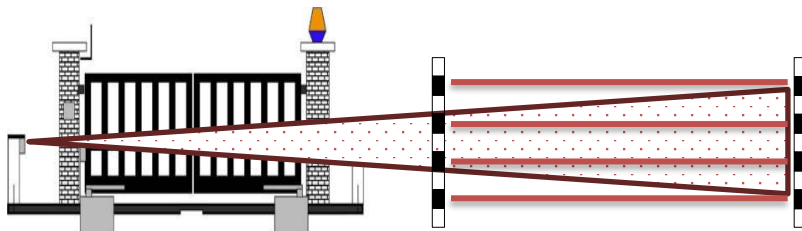

9. Installation examples

9.1 Barrier control

All Politec products can be customised according to the installation needs, including column height and consequently the number of beams inside which can vary in different ways and work in parallel or crossing.

The barriers can have both TX and RX inside, or they can be terminal barriers that have only TX or RX inside them.

It is possible to create perimeter protection of any shape and size.

Arrangement of barriers according to protection needs.

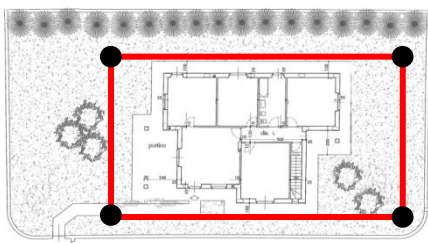

Placing barriers in a closed perimeter

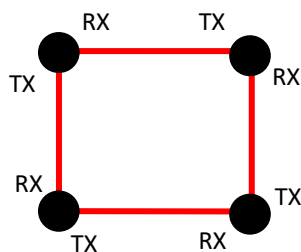

Mixed columns



Single barrier system



Terminal columns

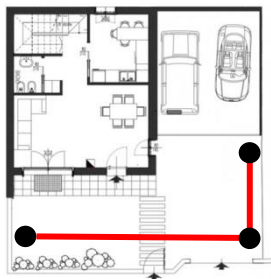

Placing barriers in an open perimeter

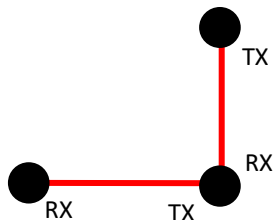

Mixed and terminal columns

10. Wiring

10.1 Type of cable

Wiring requires you to **SEPARATE** the SHIELDED cable of the 12Vdc power supply plus all the signals towards the control unit and the synchronism between the columns (e.g. 2x0.50 + Nx0.22), from the power cable of the 24Vac heaters (e.g. 2x0.75) to prevent the input of alternating voltage disturbances on the barrier.

N.B. it is absolutely necessary to shield the cable that supplies the 12 Vdc power supply and to ground the metal braid.



The sizing of the cables depends on the consumption of the columns and on the resistance of the cable itself according to the distances involved.

The table shows the cable cross-sections and the relative distances to ensure optimum performance using the LAR22 power supply (12Vdc-2.5A/24Vac-300W) and a SANDOR PLUS SMA barrier (4TX + 4RX).

CONDUCTOR CROSS-SECTION	POWER SUPPLY BOARDS 12Vdc	POWER SUPPLY HEATERS 24Vac
0.5 mm ²	165 m	35 m
0.75 mm ²	245 m	50 m
1.5 mm ²	490 m	100 m
2.5 mm ²	820 m	165 m
4 mm ²	1310 m	265 m
6 mm ²	1975 m	400 m

The LAR22 can supply up to 4 columns at the maximum extension (4TX +4RX).The LAR22 container is metallic, so it must be placed inside a room or inserted in a watertight container if used outdoors.A battery up to 18Ah can be housed in the container.

Alternatively, the LAR18 power supply (12Vdc-0.9A / 24Vac-60W) can be used to power a single column (maximum configuration 4TX +4RX).The power supply is kept in a PVC container and can offer IP68 protection if the junction boxes are made with suitable products available on the market.The LAR18 can be combined with the LARB4 battery housed in a PVC container like the LAR18 but not with the same IP rating.



10.2 Connection of cables from power supply to barrier

It is recommended to make a star-shaped connection to avoid excessive voltage drops on the power cables

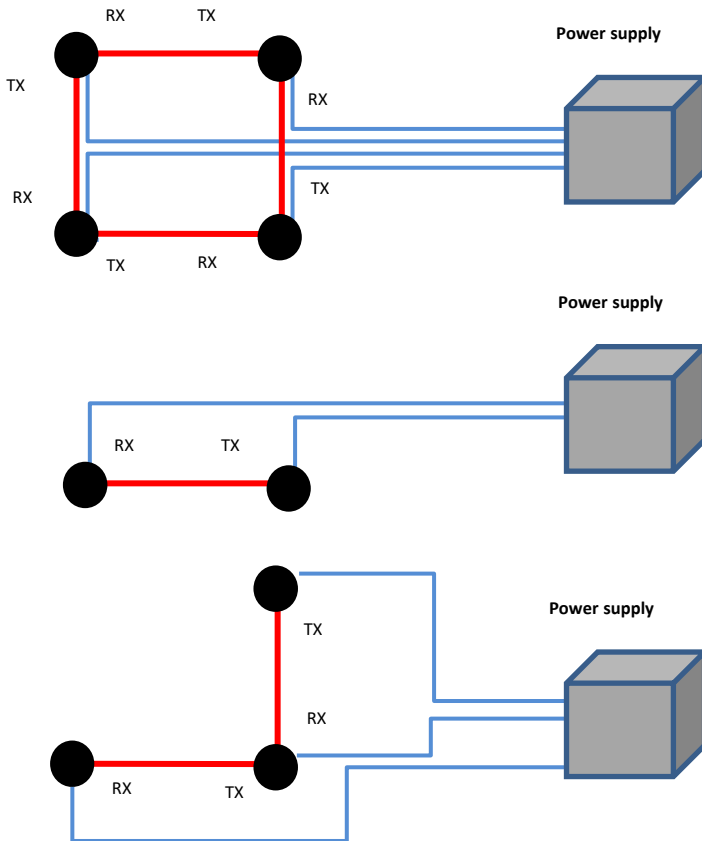

11.Connections to the MES9C terminal board

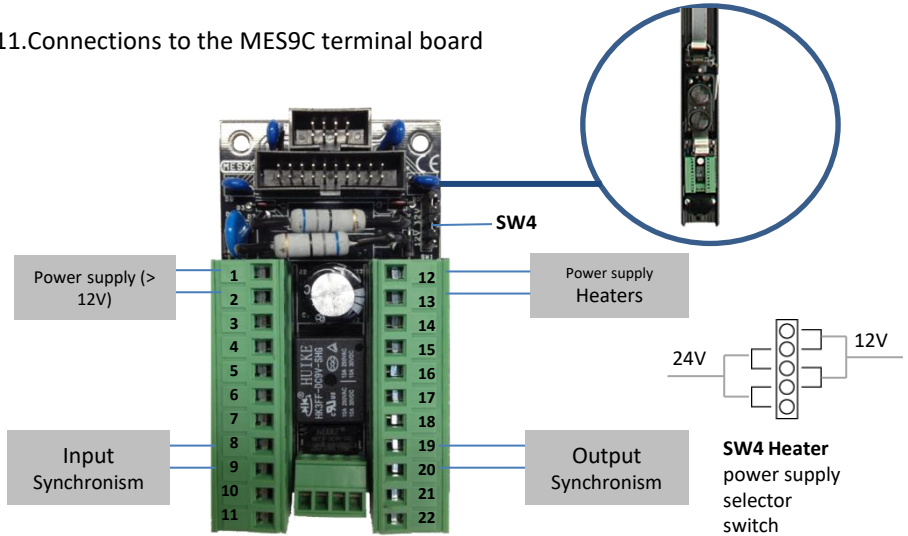

Power supply positive	+12/30 Vdc	1	12	12/24 Vac (or Vdc)	Heater power supply
Power supply negative	GND	2	13	12/24 Vac (or Vdc)	Heater power supply
Tamper output	(TMP)	3	14	BARRIER INHIBITION ON COMMAND (G.IN)	Bring negative for barrier inhibition for one minute with external impulse command . Reset is automatic after the elapsed time
Tamper output	A/P (TMP)	4	15	AND REMOTE (AND)	+12 Vdc for AND RX1 + RX2 0V for AND RANDOM
Alarm output (Normally open)	ALARM RELAY (NO)	5	16	BEAM EXCLUSION .	+12 Vdc - exclusion RX1 0 V - exclusion RX1 + RX2
Alarm output (Normally closed)	ALARM RELAY (NC)	6	17	DISQUALIFICATION OUTPUT (S.LOW)	Normal conditions high impedance; with fog negative voltage
Alarm output (Common)	ALARM RELAY (COM)	7	18	ANTIMASKING OUTPUT (A.MASK)	Normal conditions high impedance; in case of masking negative voltage
Input positive synchronism (TX => RX)	SYNCHRONISM ⁺ (+ S.IN)	8	19	+ SYNCHRONISM (+ S.OUT)	Output positive synchronism (TX => RX)
Input negative synchronism (TX => RX)	- SYNCHRONISM (- S.IN)	9	20	- SYNCHRONISM (- S.OUT)	Output negative synchronism (TX => RX)
Not in use	AME COAXIAL	10	21	AME COAXIAL	Not in use
Not in use	TRESSE COAXIAL	11	22	TRESSE COAXIAL	Not in use

11.1 Wire synchronism

TX/RX arrangement for synchronism connection

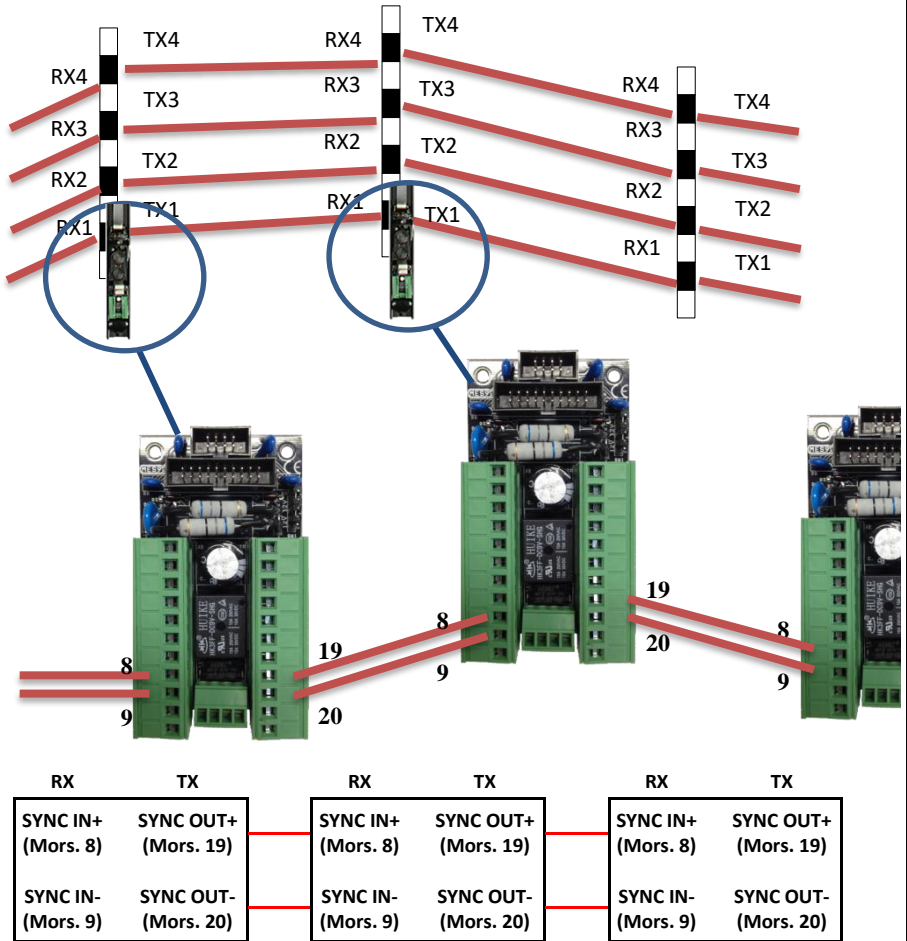

The synchronisms are to be connected as per the above diagram. The SYNC OUT corresponds to the part of the TX column and must be connected to the SYNC IN of the opposite RX column.

N.B.: It is also necessary to connect the power supply negative in common between the columns and to use shielded cables (2x0.22mm²) for the synchronisms preferably separated from the power supply, with the braid connected to the negative.



11.2 Connection for synchronism

The barrier synchronism connections can be made directly between the columns or they can be made directly in the control unit or in a junction box.

Using a cable with a shielded 2X0.22mm² cross-section, connections up to 500 m can be made. In the event of joints, the braid and shield connections must also be restored.

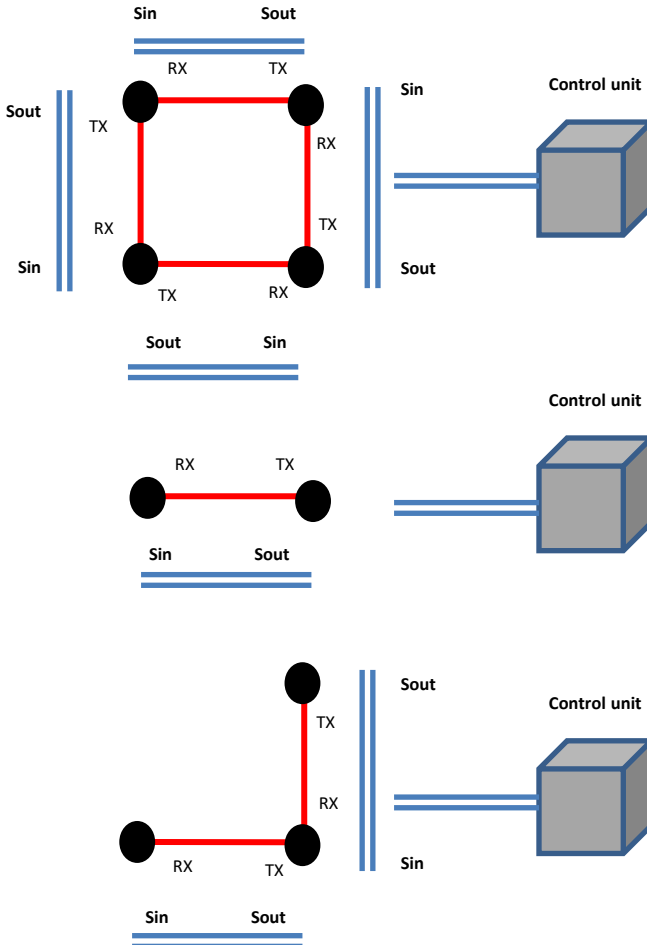

12.Barrier alignment

For correct alignment, once the columns are installed, orient the optical units of the transmitters and the optical units of the receivers towards each other, adjusting the lens holder horizontally through manual movement, after loosening the locking screw on the joint and vertically through the front screw located to the left of the lens.

Vertical orientation

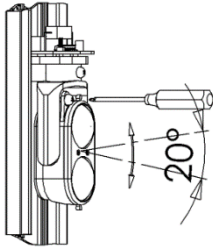

Horizontal adjustment

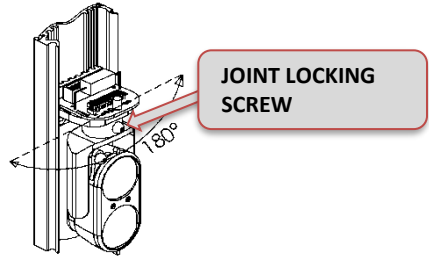

N.B.:Tighten the joint locking screw after the adjustment

12.1 Calibration using SMA system

It is possible to improve the calibration by using the supplied filter.

1. Fold the device following the pre-set folds

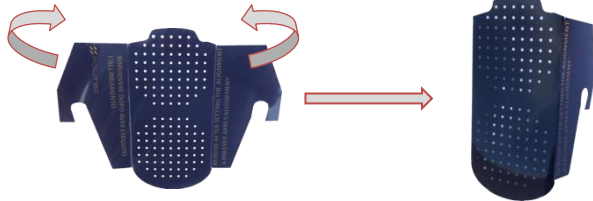

2. Position the filter in front of the TX optic inserting the two hooks on the pins of the optic fork. The filter is designed to refine the search for the alignment signal under critical conditions.



It is sufficient to apply the filter only on the TX, there is no need to repeat the operation also on the RX.

12.2 Alignment

- Power the unit electrically
- Starting from one of the system columns, press the TEST button on the first RX optic for 3 seconds or until the buzzer emits an intermittent acoustic signal, accompanied by the equally intermittent flashing of the long-range high intensity LEDs.

N.B. The frequency of the intermittent flashing is determined by the quality/quantity of signal received.

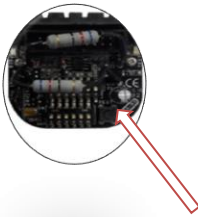

- Press the TEST button on the TX optic of the corresponding column for 5 seconds, in this case only the orange TEST led will light up.
- Orient the TX optic towards the RX optic, vertically and horizontally acting as explained above, until you find the maximum alignment.

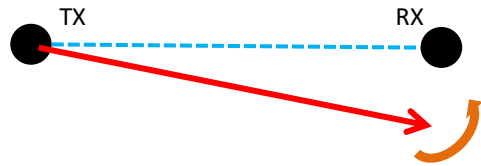

- The maximum alignment condition will be reached when the high intensity LEDs are on steady and the buzzer will emit a continuous sound, for this reason, it may be necessary to act with small movements also on the RX optic.

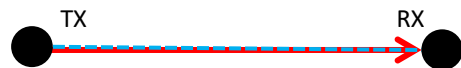

N.B.: the fixed buzzer sound has a maximum duration of 3 minutes. To obtain a good alignment it is necessary to complete a FULL rotation on the horizontal axis of the RECEIVER optic, thus performing the SCANNING of the optical signal. This operation is very useful to understand if the alignment of the optics is taking place directly on the same axis and not through reflection, therefore deceptive, because the signal value is much lower, despite having reached the hypothetical maximum alignment signal.

- The partial or total misalignment condition is signalled by the infrequent flashing of the LEDs and by the non-continuous whistle of the buzzer.
- After calibration, tighten the horizontal adjustment screw, and exit the test function by pressing the TEST button on the TX and RX optics for 3 seconds.
- Repeat all the operations on each beam of the barriers that make up the system.

At the end of the operation, remove the screen which acts as an attenuator, making sure to have found the optimal value.

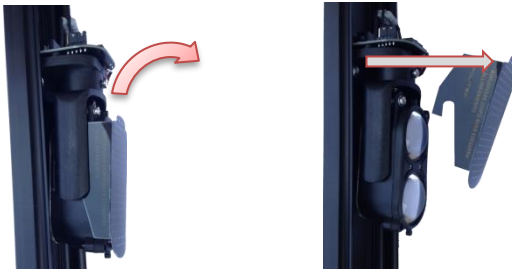

N.B.: If the barriers work with optical synchronism, to be absolutely certain that the alignment of the optics is correct (and therefore there are no false alignments due to other infrared sources, such as gate photocells), cover the TRANSMITTER optic with your hand: if the RECEIVER continues to give a continuous beep, it means that it sees another infrared source that must be turned off and eliminated.



12.3 Parallel beam calibration

Test the TX1 and RX1 optics and proceed with the calibration as explained. Then repeat the operation for each pair of optics.

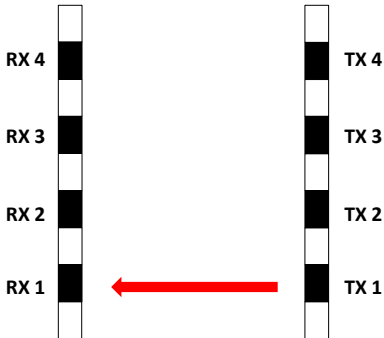

N.B.: During the alignment test phase, the activation of a TX transmitter determines the automatic shutdown of the other TX optics in the column.

12.4 Calibration with active crossing function

To activate the function, set DIP 2 to ON on the 12 DIPSWITCH unit of the MES9012.

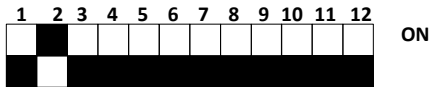

Test the TX1 and RX1 optics and proceed with the calibration as explained above but, having found the maximum alignment, keep the TX1 optic in test and exit the test only with RX1, then repeat the same operations with RX2, RX3 and RX4.

At the end, exit the test of TX1 and repeat the operation for each TX optic on each RX.

At the end of all operations, make sure that TX1 and TX4, being at the ends and most susceptible to orientation movements, are still optimally aligned with the corresponding RX1 and RX4.

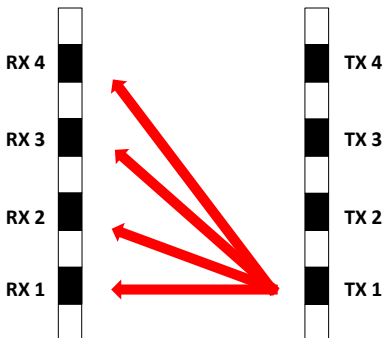

WARNING: a too close a distance between the TX and RX columns does not allow calibration with the crossing function.

13.Optical synchronism

Set DIP 4 of the 12 unit to ON and select the transmission channel from 1 to 3 (channel 1 is set by default), on the 4 unit; the selected channel must be the same both on the TX and on the RX board.

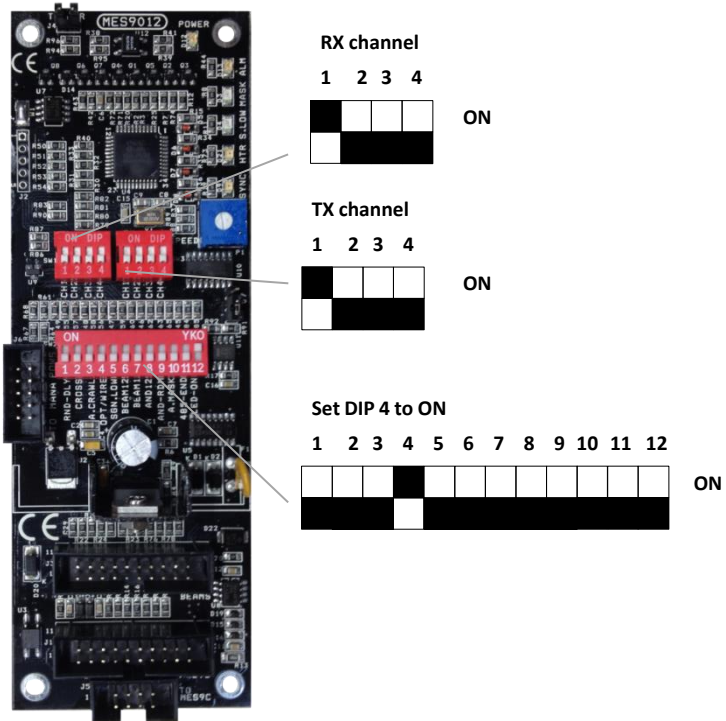

N.B.:Optical synchronism requires greater attention during the installation phases, in particular, that the receiving column is not affected by other sources of IR light, such as other barriers of the same system, gate photocells etc.

14. Basic functions

14.1 Basic settings and programming - MES9012 board

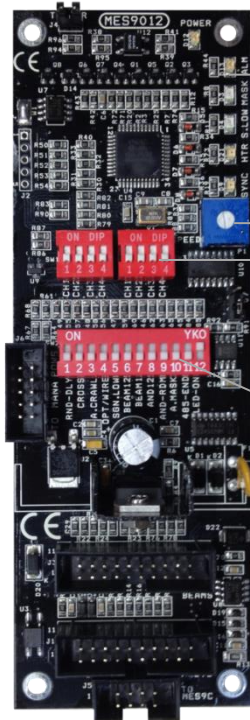

LED INDICATORS

- POWER - Lit if powered
- ALM - Lit if the barrier is in alarm
- SYNC - Very fast flashing (with presence of RX optics in the column and wired synchronism)

INTERVENTION TIME ADJUSTMENT TRIMMER

2 UNITS WITH 4 DIPS OF TRANSMISSION AND RECEPTION

- RX:1 by default - normal operation all ON - forced closed alarm relay
- TX:1 by default - normal operation all OFF - all TXs turn off

12 DIP UNIT FOR CONFIGURATION

- AND RANDOM: **DIP 9**
- AND ON BEAM 1-2: **DIP 8**
- BEAM 1 DEACTIVATION: **DIP 7**
- BEAM 1-2 DEACTIVATION: **DIP 6**
- DISQUALIFICATION FUNCTION: **DIP 5**

15. Intervention time adjustment

On the board there is a potentiometer to adjust the INTERVENTION TIME. In particular, it is possible to set the barrier for rapid (crossing while running) or slow (crossing while walking) alarms.

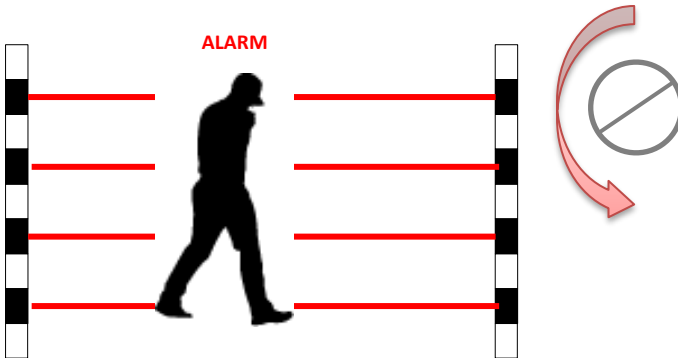

By adjusting the potentiometer anticlockwise, the intervention time is increased up to 500ms. In this condition, the alarm of a person crossing the barrier while walking is guaranteed, with the advantage of excluding the possibility of any false alarms (e.g. animal crossing).

By adjusting the potentiometer clockwise, the intervention time decreases down to 50ms. In this condition, the alarm of a person crossing the barrier running at maximum speed is guaranteed.

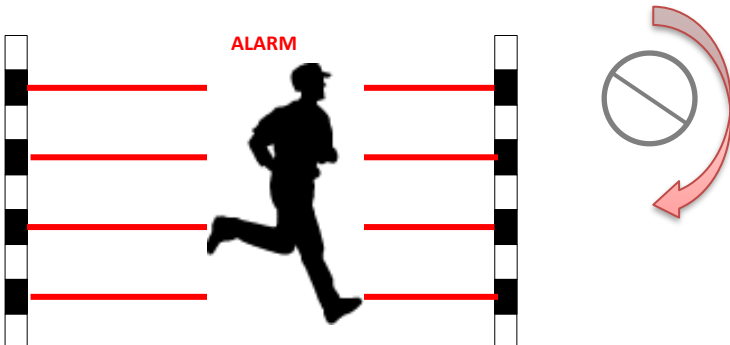

16. Appendix A: motherboard MES9012 setting and programming

16.1 Motherboard components

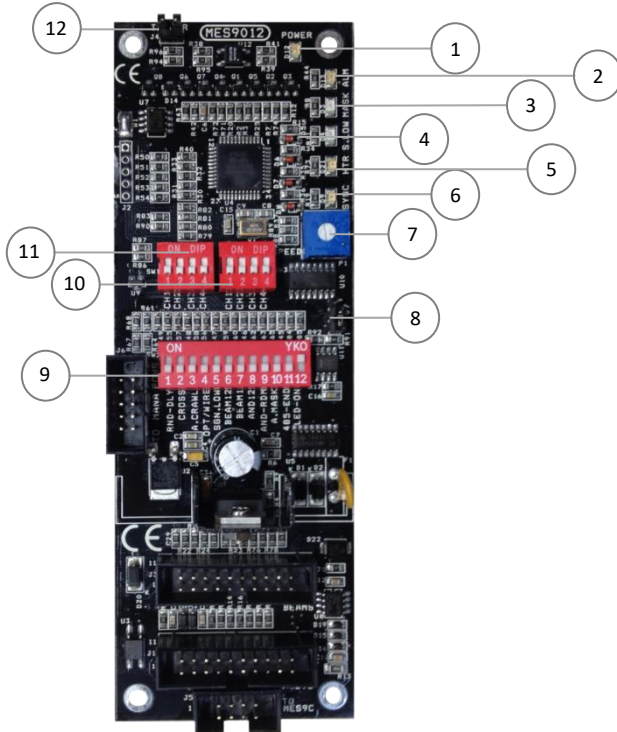

1	POWER SUPPLY LED	POWER	Red
2	ALARM LED	ALM	Red
3	MASKING LED	MASK	Green
4	DISQUALIFICATION LED	S.LOW	Green
5	HEATERS LED	HTR	Yellow
6	SYNCHRONISM	SYNC	Yellow
7	TRIMMER	Intervention time adjustment	
8	J7	DISQ1	
9	12 DIP SWITCH UNIT	Function selector	
10	4 DIP SWITCH UNIT TX	Function selector	
11	4 DIP SWITCH UNIT RX	Function selector	
12	TAMPER	Column tamper connection	



16.2 LED signal operation

The MES9012 motherboard has six control and signalling LEDs, which can be activated by setting DIP 12 on the unit with 12 on the board to ON.

At the end of the test it is advisable to reposition the DIP on OFF, both to avoid catching the signals and to reduce the system consumption.

POWER <i>Power supply on LED</i>	The POWER LED is the only one that is always on in normal operating conditions, it confirms that the board is correctly powered.
ALM LED <i>Alarm LED</i>	Normally off, if lit, it indicates the alarm status. The alarm condition will depend on the setting of the jumpers making up the board and on the intervention delay set on the trimmer SPEED which will be adjustable from a minimum of 50 mSec to 500 mSec. Increases clockwise.
MASK LED <i>Masking <u>signal</u></i>	The lighting up of the MASK LED indicates the presence of an unwanted modulated infrared signal. ANTIMASK can be signalled on the terminal board in the presence of an attempt at masking N.B.: In normal operating conditions, the LED must remain off. If it remains on or flashing, check the correct setting of the beam selection jumpers on the various transmitters of the other column.
SIG LOW LED <i>Low signal (<u>disqualification</u>)</i>	The lighting up of the SIG LOW LED indicates the presence of THICK FOG. In the presence of thick fog, before having an alarm condition for lack of signal, the SIG LOW LED lights up and the DISQUALIFICATION signal can be displayed on the terminal board N.B.: By inserting the DIP SIG LOW in the ON position, and with the disqualification intervention, the barrier is excluded, which will become operational again as soon as the fog has cleared.
HTR LED <i>LED confirming that the heating system is on</i>	Electronically controlled automatic heating system to guarantee an internal temperature between 17°C and 22°C under all climatic conditions. Normally off, when on the heating is active.
SYNC LED <i>LED confirming the operation of the synchronism system</i>	The SYNC LED indicates by continuous flashing the correct wiring and functioning of the synchronisms between transmitters and receivers.



16.3 Characteristics of settings

On the MES9012 motherboard, it is possible to configure different functional conditions, using the 12 DIP SWITCH unit.

12 DIP SWITCH UNIT

1	RND DLY ON	In the ON position the alarm is generated each time with a random delay varying from 0 to 1 sec. This function is used to confuse and mislead the intruder who wants to identify the detection system.
	TEST HEATERS	Raise and lower DIP 1 3 times to activate the heaters for 20 minutes bypassing the thermostat.
2	CROSSING	In the ON position it activates the cross beam detection
3	A.CRAWL	In the OFF position the "normal" functioning of the barrier is set, set to ON the "ANTI-CRAWLING" mode is activated, this means that obscuring the RX1 beam (the first at the bottom) for at least 2 sec. causes the alarm condition, regardless of whether it was previously set to OR or AND.
4	SYNC	In the ON position the OPTICAL SYNCHRONISM is activated, in the OFF position the WIRED SYNCHRONISM is used
5	DISQ	In the ON position it activates the disqualification function (with at least two optics that detect a low signal).
6	BEAM OFF 1+2	In the ON position, the first two beams are excluded, starting from the bottom while the remaining beams continue to work.The function can also be programmed remotely by giving a negative 0 V command on the terminal marked BEAM on the terminal board.If you want to activate this function remotely, DIP6 must remain OFF.
	BEAM OFF 1	In the ON position, the first beam at the bottom is excluded, while the rest continue to work.The function can also be programmed remotely by giving a positive 12 V command on the terminal marked BEAM on the MES9C terminal board.If you want to activate this function remotely, DIP7 must remain OFF.
8	AND 1 + 2	In the ON position the AND function of the first two receivers is obtained, that is to say that both must be interrupted to generate the alarm condition, while the remaining Rxs remain individually alarmable.This configuration can be useful in the presence of tall grass or small animals.The function can also be programmed remotely by giving a positive 12V command on the terminal marked AND on the terminal board.If you want to activate this function remotely, DIP8 must remain OFF.
	AND RND	In the ON position, the random AND between two RXs is obtained, that is to say that to have an alarm condition, at least two RXs must always be alarmed from all those used. The function can also be programmed remotely by giving a negative 0 V command on the terminal marked AND on the terminal board.If you want to activate this function remotely, DIP9 must remain OFF.
9	AND RND	In the ON position, the random AND between two RXs is obtained, that is to say that to have an alarm condition, at least two RXs must always be alarmed from all those used. The function can also be programmed remotely by giving a negative 0 V command on the terminal marked AND on the terminal board.If you want to activate this function remotely, DIP9 must remain OFF.
10	ANTIMASK	In the ON position the ANTIMASK function is enabled by activating the output on the MES9C terminal board.
11	CLOSE RS485	In the ON position it closes the RS485 communication.To finish it is necessary to put ON only on the board of the furthest column of the entire line.
12	LEDS	In the ON position it activates the LEDs.



4 DIP SWITCH UNIT TX

TX TEST	By setting all the DIP switches to OFF, all the transmitters in the column are turned off; by moving all the DIP switches to ON the transmitters are activated at high frequency in order to allow a first visual contact between the transmitter and the receiver in case of difficulty at long distances.
1 CH 1	Wired synchronism: normal operation of the transmitters
	Optical synchronism: operation with transmission frequency 1
2 CH 2	Wired synchronism: no operation
	Optical synchronism: operation with transmission frequency 2
3 CH 3	Wired synchronism: no operation
	Optical synchronism: operation with transmission frequency 3
4 CH 4	Wired synchronism: no operation
	Optical synchronism: operation with transmission frequency 4, only 2 transmitters are active

4 DIP SWITCH UNIT RX

TERMINAL and TX ONLY	All DIP switches are ON: the alarm relay is deactivated. This setting is used when the column has only transmitter optics
1 CH 1	Wired synchronism: normal operation of the receivers
	Optical synchronism: operation with reception frequency 1
2 CH 2	Wired synchronism: no operation
	Optical synchronism: operation with reception frequency 2
3 CH 3	Wired synchronism: no operation
	Optical synchronism: operation with reception frequency 3
4 CH 4	Wired synchronism: no operation
	Optical synchronism: operation with reception frequency 4, only 2 receivers are active

DISQ1 JUMPER:J7

If the disqualification function has been activated on DIP SWITCH 12 via DIP 5 in ON, in some cases and particular geographical areas, it may be useful to increase the sensitivity of the disqualification by setting jumper J7 to ON.



17. Appendix B: maximum configuration of 4TX +4RX optics

17.1 Transmitter optics

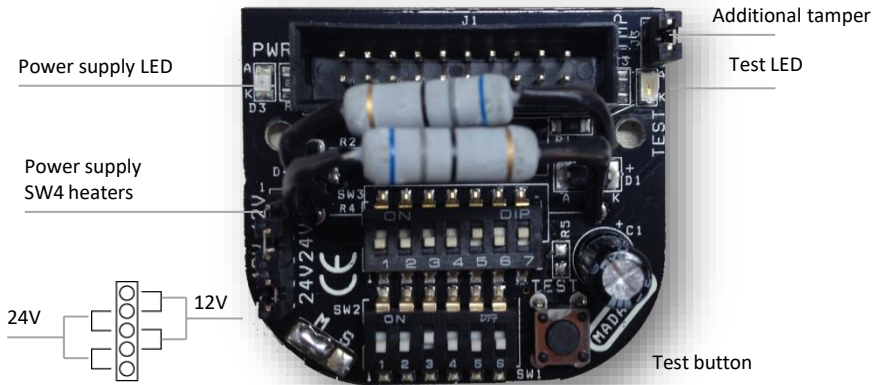

	1	2	3	4	5	6	7	1	2	3	4	5	6	
TX4	Black	White	White	White	White	White	White	White	White	White	White	White	White	ON
TX3	Black	White	White	Black	White	Black	White	White	White	White	White	White	White	ON
TX2	Black	White	White	White	White	White	Black	White	Black	White	White	White	Black	ON
TX1	Black	White	White	White	White	White	Black	White	White	White	White	Black	White	ON

With DIP 7 in ON (as default) and with the power supply LED on, the TX optic functioning is verified. The power supply of the heaters is set by default to 24V; 12V can be used by changing the jumper configuration (SW4) on all optics and on the MES 9 C board.

The voltage can be both AC and DC.

N.B.:The settings relating to the addressing of the optics are already set by default.



17.2 Receiver optics

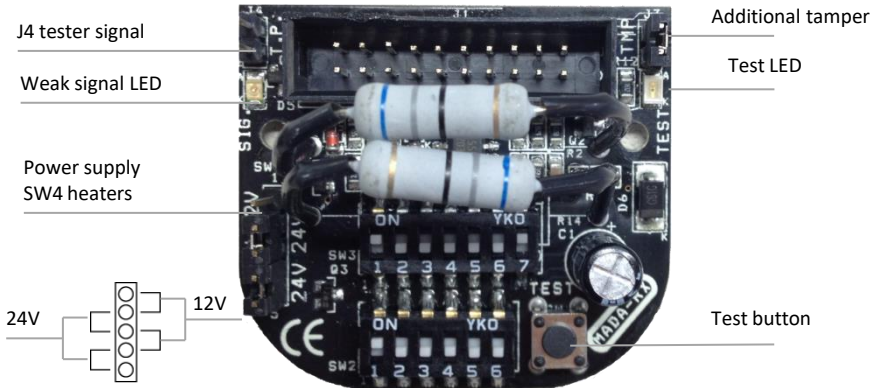

	1	2	3	4	5	6	7	1	2	3	4	5	6	
RX4	Black	White	White	Black	White	White	Black	White	Black	White	White	Black	White	ON
RX3	White	Black	White	White	Black	White	White	White	Black	White	White	Black	White	ON
RX2	White	Black	White	White	White	Black	White	White	Black	White	White	White	Black	ON
RX1	Black	White	White	White	White	Black	White	White	Black	White	White	White	Black	ON

With DIP 7 in ON (as default) and when the power supply LED lights up, the functioning of the RX optic is verified.

The power supply of the heaters is set by default to 24V; 12V can be used by changing the jumper configuration (SW4) on all optics and on the MES 9 C board.

The voltage can be both AC and DC.

Jumper J4 reads the value of the alignment signal, expressed in volts.

N.B.:The settings relating to the addressing of the optics are already set by default.

N.B.:The barrier can result in an alarm even if the WEAK SIGNAL LED is off.The cause may be the lack of synchronism or a misaligned transmitter.



18. Appendix C: 3TX +3RX or 2TX +2RX configuration

By default, the columns supplied with 3 +3 or 2 +2 total beams are set during the factory testing phase. If it is necessary to change the original number of Beams in the field, DIP SWITCH 6 or 7 must be set to ON on the 12 unit of the MES9012 motherboard, as shown below:

18.1 Setting of models with 3 Beams

The DIP SWITCH setting on the optics in the column is set as follows:

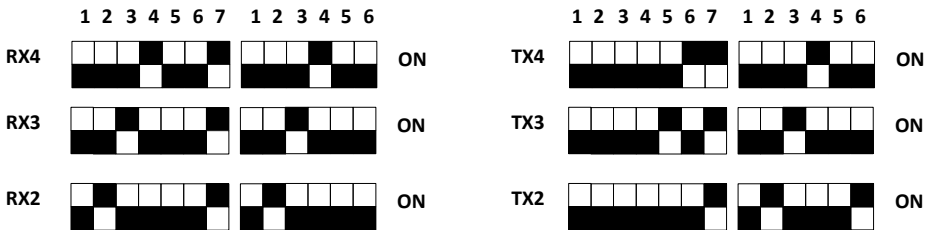

Set to ON DIP 7 of the 12 unit on the MES9012 motherboard Receivers side to exclude RX1

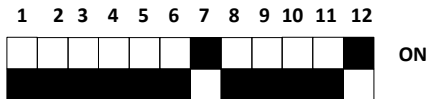

18.2 Setting of models with 2 Beams

The DIP SWITCH setting on the optics in the column is set as follows:

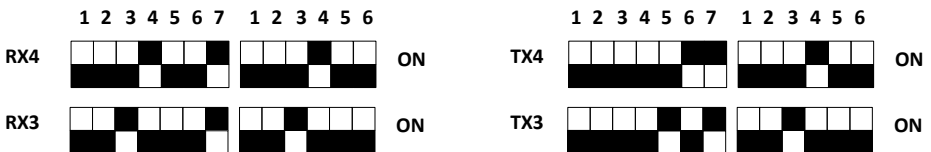

Set to ON DIP 6 of the 12 unit on the MES9012 motherboard Receivers side to exclude RX1 + RX2

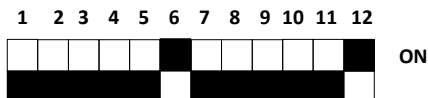

19. Appendix D: serial connection to the ADEBUS concentrator

Each column can be connected via the RS485 serial bus to the ADEBUS control unit for programming, control and local or remote management of the system.

For further information, refer to the "Adebus & AdebusExplorer installation manual".

N.B.: To use the ADEBUS system it is **MANDATORY** to use wired synchronism.

N.B.: It is possible to use the two additional wires of the bus cable for synchronism (red-black pair)

19.1 Serial port connection and synchronism for each barrier.

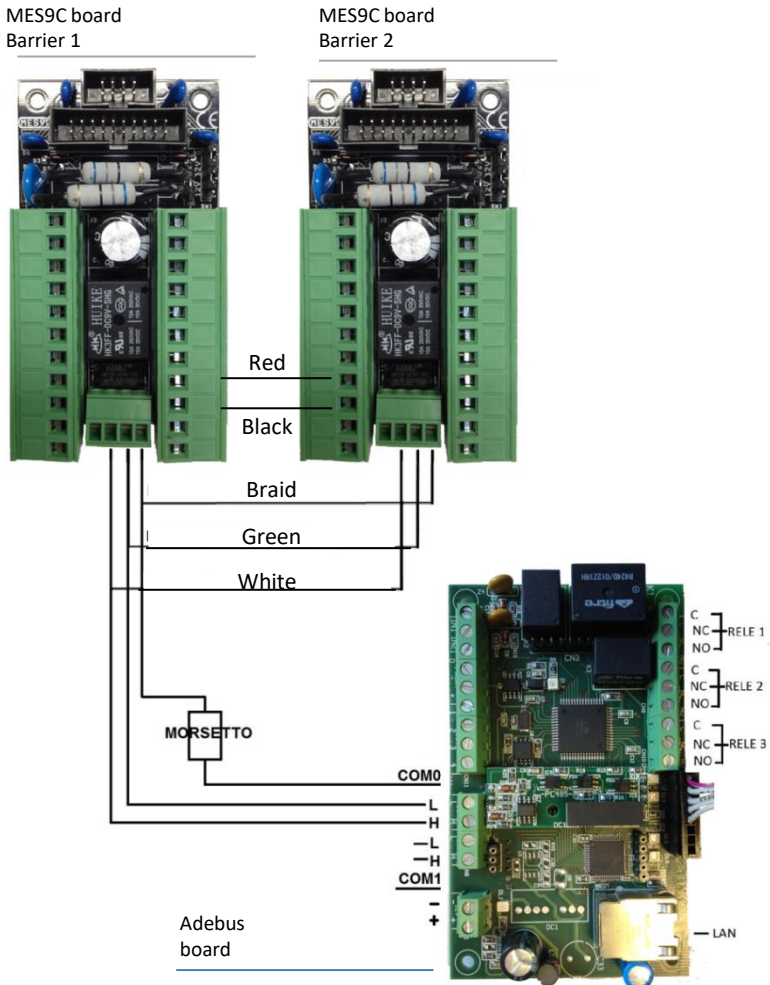

20. Appendix E: single barrier with optical synchronism

In the case of a single barrier with optical synchronism, set the RX channel of a board different from the TX channel of the same, only if the barrier consists of 6 or 8 beams as shown below. With a maximum number of 4 beams, only set DIP 1 to ON, on all 4 DIP units.

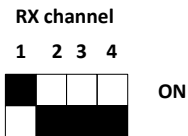
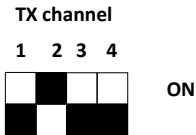
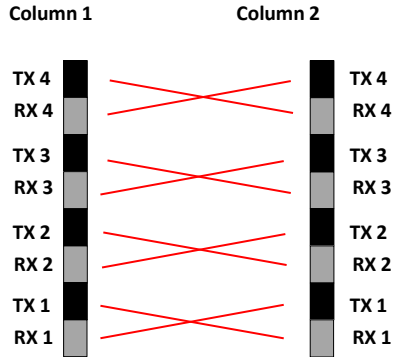

Column 1



Column 2

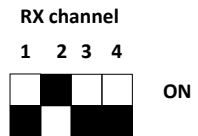
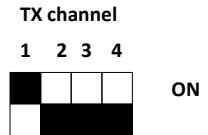

21. Technical specifications

OUTDOOR RANGE	100 m
INDOOR RANGE	200 m
SYNCHRONISM	Wired / Optical
OPTICAL SENSORS	Double optics with impulse beams 950 nm
CALIBRATION	Parallel or crossed beams
DISQUALIFICATION	Automatic, if enabled, with external signalling, O.C.:NO to GND
MASKING	Masking detection with other Infrared signal with outward signalling, O.C.:NA to GND
OPERATING TEMPERATURE	- 25°C / + 65°C. Heater kit available for temperatures down to -50°C
ALIGNMENT ANGLES	20° Vertical - 180° horizontal
DETECTION SYSTEM	OR / AND 1st and 2nd / AND random
BEAM EXCLUSION	1st / 1st and 2nd
REMOTE CONTROL	AND Random / AND 1st and 2nd beam / exclusion 1st or 1st and 2nd / Barrier deactivation for 60s
EXTERNAL SCREEN	Infrared with UV filter
OUTPUTS	Alarm and tamper relay
PROFILE DIMENSIONS WxDxH	60mm x 60mm x from 500mm to 4000mm
PROTECTION RATING	IP 56
WARRANTY	2 years

STANDARD MODELS

Total beams	2TX + 2RX	3TX + 3RX	4TX + 4RX
Power supply	12-24Vdc	12-24Vdc	12-24Vdc
Consumption	135 mA	140 mA	150 mA
Heaters in column	25W 24Vac with thermostat	35W 24Vac with thermostat	45W 24Vac with thermostat

TERMINAL MODELS

Total beams	2TX or 2RX	3TX or 3RX	4TX or 4RX
Power supply	12-24Vdc	12-24Vdc	12-24Vdc
Consumption	80 mA	100 mA	135 mA
Column internal heaters	15W 24Vac with thermostat	20W 24Vac with thermostat	25W 24Vac with thermostat



22.F.A.Q.

<p>I can't align</p>	<p>Check that there are no obstacles of any kind interposed between RX and TX and that the conformance of the site does not represent an impediment;</p>
	<p><u>N.B. remember to reactivate the optics once the alignment operation is finished.</u></p>
	<p>Make sure that the TX is in the test phase (orange LED of the optic in question on and the others off);</p>
	<p>Make sure that the connectors are well inserted and that the DIP configuration is correct;</p>
	<p>Check that the power supply on the terminal board is sufficient;</p>
	<p>Use the shielded cable for the power supply by connecting the braiding to the earth (in case of persistent problem, it is recommended to connect the alarm and power supply/tamper with two separate shielded cables);</p>
	<p>Check the correct sizing of the power cables;</p>
	<p>Make sure there are no external light sources that interfere with the correct reading of the signal (gate photocells, other barriers, infrared etc.);</p>
	<p>For barriers with multiple devices positioned on the same line, it is necessary to switch off the TXs on which the alignment operation is not being performed; to do this, the four DIP TX must be moved (Chap.11) to the ON position, checking that the orange LEDs are off;</p>
	<p>If the system uses a switching power supply, replace it with the linear one to reject electrical disturbances coming from the network, we recommend the LAR22/LAR18 power supply.</p>
<p>The system goes into disqualification even in the absence of fog</p>	<p>Make sure that the power supply of the heaters is greater than 20 Vac <u>at the barrier terminal board</u> .</p>
	<p>Check the alignment accuracy of each individual optic and, if necessary, carry out the procedure by performing a complete scan, making sure that there are no light sources that can influence the calibration;</p>
	<p>For more precise alignment, position one side of the column cover in front of the lenses in order to have two surfaces interposed between TX and RX to double the attenuation of the beam.</p>



After accurately aligning the sensor (LED light on steady and continuous BEEP) the system remains in alarm	Make sure that all the barriers negatives are in common with each other and with the control unit negative;
	Make sure that the connectors are well inserted and that the DIP configuration is correct;
	The TX terminal column has the ALARM LED on instead of the SYNC LED;
	Check that there is synchronism, the SYNC-RX yellow LED on (TX), otherwise the alarm will not be constant, then recheck the connections (see chap. 7) making sure that the terminal board is well inserted;
	Check which receiver optic does not pick up the corresponding transmitter. To do this set the AND mode, if the barrier is no longer in alarm, obscure each beam individually finding the one that does not generate the general alarm, this beam is not aligned;
	Make sure that there are no external light sources that interfere with the correct reading of the signal (gate photocells, other barriers, infrared etc.), to do this it is possible to verify masking by activating DIP 10 (antimasking, see chapters 10 and 12);
	Use the shielded cable for separate power supply and synchronism by connecting the braid to the earth;
	Check the sizing of the power cables;
	If the system uses a switching power supply, replace it with the linear one to reject electrical disturbances coming from the network;
The system goes into alarm with fog and rain	Check that the fog disqualification function is active (see chap. 12);
	Make sure that the power supply of the heaters is greater than 20 Vac at the barrier terminal board .
	In case of very thick fog activate DISQ1 (see chap. 12);
	Make sure that the structure is well sealed and check that there are not already disturbing elements inside (water, insects etc.);
	Check the alignment accuracy of each individual optic and, if necessary, carry out the procedure by performing a complete scan, making sure that there are no light sources that can influence the calibration;
	For more precise alignment, position one side of the column cover in front of the lenses in order to have two surfaces interposed between TX and RX to double the attenuation of the beam.

Repeated false alarms	If they are caused by the passage of animals, use the AND, BEAM 1 functions or increase the intervention time.
	Check the alignment accuracy of each individual optic and, if necessary, carry out the procedure by performing a complete scan, making sure that there are no light sources that can influence the calibration.
	Make sure that the power supply of the heaters is greater than 20 Vac at the barrier terminal board.
	Use the shielded cable for separate power supply and synchronism by connecting the braid to the earth;
	Check the correct sizing of the power cables;
	If the system uses a switching power supply, replace it with the linear one to reject electrical disturbances coming from the network, we recommend the LAR22 power supply;
	If possible, increase the intervention time.

23.Product disposal.

All components of this barrier are an integral part of the equipment and must be disposed of together with it. Just as with installation operations, also at the end of life of these products, the dismantling operations must be carried out by qualified personnel. These products are made up of various types of materials: some can be recycled and others must be disposed of. Find out about available recycling or disposal systems for this category of products governed by regulations in force in your area.

Warning! Some parts of the products may contain polluting or dangerous substances which, if dispersed in the environment, could result in harmful effects on the environment itself and on human health. As indicated by the symbol on the side, it is forbidden to throw these products in domestic waste. Therefore, carry out "separate collection" for disposal, according to the methods stipulated by the regulations in force in your area or return the products to the seller when purchasing a new equivalent product.

Warning! Local regulations can impose heavy penalties for incorrect disposal of these products.



For technical support, contact your security systems distributor

